

120V PLUG-IN CARBON MONOXIDE ALARM WITH BATTERY BACK-UP AND TEST/SILENCE

Reliable Protection, Maximum Convenience!

- Just install the battery, plug the alarm into a regular outlet, test, and it's ready to go!
- Battery back-up keeps alarm working if electricity fails.

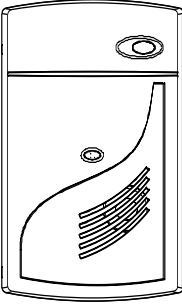

120V AC ~
60 Hz 0.09A

LISTED TO
UL 2034
Model CO604

Printed in Mexico
M08-0190-004 P 04/09

IMPORTANT!
PLEASE READ CAREFULLY AND SAVE.

This user's manual contains important information about your Carbon Monoxide (CO) Alarm's operation. If you are installing this CO alarm for use by others, you must leave this manual—or a copy of it—with the end user.

© 2009 BRK Brands, Inc. All rights reserved.
Distributed by BRK Brands, Inc.
3901 Liberty Street Road, Aurora, IL 60504-8122
Consumer Affairs: (800) 323-9005 • www.firstalert.com

INTRODUCTION**BASIC SAFETY INFORMATION****IMPORTANT!**

- Dangers, Warnings, and Cautions alert you to important operating instructions or to potentially hazardous situations. Pay special attention to these items.
- THIS IS NOT A SMOKE ALARM!** This CO Alarm is designed to detect carbon monoxide from ANY source of combustion. It is NOT designed to detect smoke, fire, or any other gas.
- This CO Alarm is approved for use in single-family residences. It is NOT designed for marine or RV use.

CAUTION!

- This CO Alarm will only indicate the presence of carbon monoxide gas at the sensor. Carbon monoxide gas may be present in other areas.

WARNING!

- The Silence Feature is for your convenience only and will not correct a CO problem. Always check your home for a potential problem after any alarm. Failure to do so can result in injury or death.
- This CO Alarm should receive continuous 120VAC, 60 Hz, pure sine wave electrical power. (The battery is meant for emergency back-up only). Do not use in an extension cord or outlet controlled by a dimmer or switch. In order for the emergency battery back-up to work, a working (fresh) battery must be properly installed.

- NEVER ignore your Carbon Monoxide Alarm if it alarms. Refer to "If Your CO Alarm Sounds" for more information. Failure to do so can result in injury or death.

- Test the CO Alarm once a week. If the CO Alarm ever fails to test correctly, have it replaced immediately! If the CO Alarm is not working properly, it cannot alert you to a problem.

- This product is intended for use in ordinary indoor locations of family living units. It is not designed to measure CO levels in compliance with Occupational Safety and Health Administration (OSHA) commercial or industrial standards. Individuals with medical conditions that may make them more sensitive to carbon monoxide may consider using warning devices which provide audible and visual signals for carbon monoxide concentrations under 30 ppm. For additional information on carbon monoxide and your medical condition contact your physician.

HOW YOUR CO ALARM WORKS**GENERAL INFORMATION****CAUTION!**

Leave your CO Alarm plugged in year-round. CO problems can occur any time during the year, and this Alarm can only alert you if it is plugged in and receiving power.

This CO Alarm is intended for use in a standard, unswitched 120V AC wall outlet. It is not intended for use in extension cords, power strips, or outlets controlled by a switch or dimmer. These items may not provide continuous power to the unit. When fully powered, the unit samples the air and takes a new reading about every second. A microchip inside the unit stores each reading, and remembers the levels of CO it has been exposed to over time. The Alarm sounds when it has been exposed to a "critical" level of CO (measured in parts per million or "ppm") within a specified time (measured in minutes). This CO Alarm features a permanently installed sensor, an indicator light, and an 85 dB alarm horn. It also has a Silence Feature to temporarily quiet the alarm horn.

MALFUNCTION WARNING

This unit performs self-diagnostic tests approximately every second. If the Alarm malfunctions, replace it immediately.

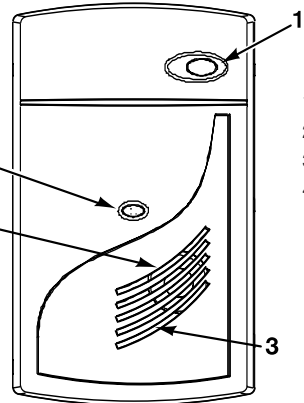
THE COVER OF YOUR CO ALARM

- Test/Silence Button
- POWER/ALARM Light (Red)
- Air Vents
- Alarm Horn: 85 dB audible alarm for test, alarm, and unit malfunction warning

This CO Alarm is intended for use in a standard, unswitched 120V AC wall outlet. It is not intended for use in extension cords, power strips, or outlets controlled by a switch or dimmer. These items may not provide continuous power to the unit. When fully powered, the unit samples the air and takes a new reading about every second. A microchip inside the unit stores each reading, and remembers the levels of CO it has been exposed to over time. The Alarm sounds when it has been exposed to a "critical" level of CO (measured in parts per million or "ppm") within a specified time (measured in minutes). This CO Alarm features a permanently installed sensor, an indicator light, and an 85 dB alarm horn. It also has a Silence Feature to temporarily quiet the alarm horn.

UNDERSTANDING YOUR CO ALARM**What you see and hear during installation****WHEN YOU FIRST INSTALL THE BATTERY:**

HORN: Silent
POWER/ALARM Light: Flashes once a minute

UNDER NORMAL CONDITIONS (AC POWER):
HORN: Silent
POWER/ALARM LIGHT: Shines continuously

WHEN YOU FIRST PLUG-IN THE CO ALARM:

HORN: Silent
POWER/ALARM LIGHT: Shines continuously

WHEN YOU TEST THE CO ALARM:
HORN: Sounds loudly - 4 beeps, pause, 4 beeps, pause
POWER/ALARM LIGHT: Flashes rapidly

What you see and hear under different conditions**DURING A POWER FAILURE (IN BATTERY BACK-UP):**

HORN: Silent
POWER/ALARM LIGHT: Flashes once a minute.

IF THE CO ALARM IS NOT OPERATING PROPERLY:

HORN: Three chirps every minute
POWER/ALARM LIGHT: Flashes three times in sync with the horn.

WHEN THE ELECTRICITY COMES BACK ON:

HORN: Silent
POWER/ALARM LIGHT: Shines continuously.

IF THE CO ALARM HAS REACHED ITS END OF LIFE:

HORN: Five chirps every minute
POWER/ALARM LIGHT: Flashes five times in sync with the horn.

IF BATTERY BECOMES LOW OR IS MISSING:

HORN: Chirps once a minute*
POWER/ALARM LIGHT: Flashes once a minute

What you see and hear if CO is detected**PRE-ALARM LEVELS:**

HORN: Silent
POWER/ALARM LIGHT: On continuously

IF YOU SILENCE THE ALARM:

HORN: Silent for about 4 minutes*
POWER/ALARM LIGHT: Flashes rapidly

ALARM LEVELS OF CO ARE DETECTED:

HORN: Sounds loudly - 4 beeps, pause, 4 beeps, pause. This sequence repeats for as long as the unit is in alarm*

*Note: After 4 minutes, if CO levels drop below alarm levels, the unit will remain silent and return to normal operation. If CO presence still indicates a potentially dangerous situation, the horn will sound again.

POWER/ALARM LIGHT:

Flashes rapidly
*Note: If unit goes into alarm under battery back-up power, the regular 4 beeps-brief pause cycle will repeat for four minutes. After four minutes, the pause will increase to 1 minute.

IF THE CO LEVELS RETURN TO NORMAL:

HORN: Silent
POWER/ALARM LIGHT: Shines continuously

INSTALLATION**WHERE TO INSTALL CO ALARMS**

The National Fire Protection Association (NFPA) recommends that a CO Alarm should be centrally located outside of each separate sleeping area in the immediate vicinity of the bedrooms. For added protection, install additional CO Alarms in each separate bedroom, and on every level of your home.

If your bedroom hallway is longer than 40 feet (12 meters), install a CO Alarm at BOTH ends of the hallway.

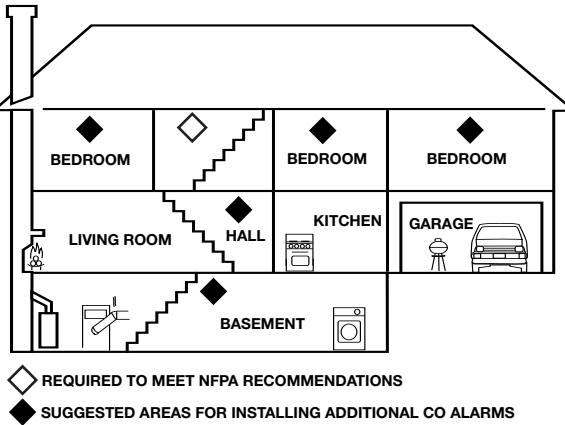

◆ REQUIRED TO MEET NFPA RECOMMENDATIONS

◆ SUGGESTED AREAS FOR INSTALLING ADDITIONAL CO ALARMS

In a Single-level Home:

- Install at least one CO Alarm near or within each separate sleeping area.
- For added protection, install an additional CO Alarm at least 20 feet (6 meters) away from the furnace or fuel burning heat source.

In a Multi-level Home:

- Install at least one CO Alarm near or within each separate sleeping area.
- For added protection, install at least one CO Alarm on each level of the home. If you have a basement, install that CO Alarm at the top of the basement stairs.
- For added protection, install an additional CO Alarm at least 20 feet (6 meters) away from the furnace or fuel burning heat source.

WARNING!

This unit should receive continuous electrical power. (The battery is meant for emergency back-up only). Choose an outlet where it can't be accidentally unplugged or switched off by children. Keep small children away from the unit. Teach them not to play with it or unplug it. Explain what the alarms mean.

WHERE CO ALARMS SHOULD NOT BE INSTALLED**DO NOT locate this CO Alarm:**

- In garages, kitchens, furnace rooms, or in any extremely dusty, dirty or greasy areas.
- Closer than 15 feet (4.6 meters) from a furnace or other fuel burning heat source, or fuel burning appliances like a water heater.
- Within 5 feet (1.5 meters) of any cooking appliance.
- In extremely humid areas. This Alarm should be at least 10 feet (3 meters) from a bath or shower, sauna, humidifier, vaporizer, dishwasher, laundry room, utility room or other source of high humidity.
- In areas where temperature is colder than 40° F (4° C) or hotter than 100° F (38° C). These areas include non-air-conditioned crawl spaces, unfinished attics, uninsulated or poorly insulated ceilings, porches, and garages.
- In turbulent air, like near ceiling fans, heat vents, air conditioners, fresh air returns, or open windows. Blowing air may prevent CO from reaching the sensors.
- In direct sunlight.
- In outlets covered by curtains or other obstruction.

WARNING!

- This CO Alarm is designed for use inside a single-family home or apartment. It is not meant to be used in common lobbies, hallways, or basements of multi-family buildings unless working CO Alarms are also installed in each family living unit. CO Alarms in common areas may not be heard from inside individual family living units.

- This CO Alarm alone is not a suitable substitute for complete detection systems in places which house many people, like hotels or dormitories, unless a CO Alarm is also placed in each unit.
- DO NOT use this CO Alarm in warehouses, industrial or commercial buildings, special-purpose non-residential buildings, RVs, boats, or airplanes. This CO Alarm is specifically designed for residential use, and may not provide adequate protection in non-residential applications.

HOW TO INSTALL YOUR CO ALARM

IMPORTANT! Read all instructions before using this product.

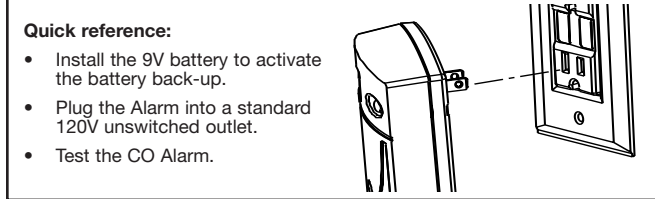

- Quick reference:**
- Install the 9V battery to activate the battery back-up.
 - Plug the Alarm into a standard 120V unswitched outlet.
 - Test the CO Alarm.

TO ACTIVATE OR CHANGE BATTERY BACK-UP

- Open the battery compartment on the back of the Alarm.
- Insert the new battery, making sure it snaps completely into the battery terminals and cannot be shaken loose.
- Close the battery compartment, then test the battery back-up by pressing the Test/Silence button.
- Plug the CO Alarm into the outlet.

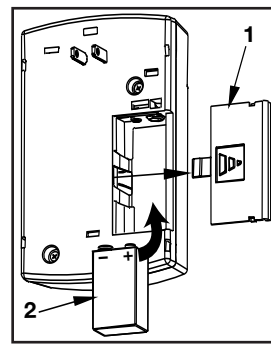
**IMPORTANT!**

The battery back-up is designed to provide emergency power to the CO Alarm for 2-3 days. Actual back-up time depends on the strength (freshness) of the battery. The battery back-up will not work unless a good battery is properly installed.

PLUG THE ALARM INTO AN OUTLET**WARNING!**

This CO Alarm should receive continuous electrical power. The battery is meant for emergency back-up only. Do not plug this Alarm into an outlet controlled by a dimmer or switch.

- Plug the unit into a standard UNSWITCHED 120V AC outlet. The unit should be located where it can wake you if it alarms at night.
- Make sure the POWER/ALARM light shines continuously when you plug it in.
- Test by pressing the Test/Silence button firmly until the unit sounds: 4 beeps, pause, 4 beeps. During testing, the POWER/ALARM light will flash. This is normal.

PREPARE YOUR ALARM LABELS

Find the pair of self-adhesive labels included with this CO Alarm.

- On each label write in the phone number of your emergency responder (like 911) and a qualified appliance technician.
- Place one label near the CO Alarm, and the other label in the "fresh air" location you plan to go if the alarm sounds.

NOTE: A qualified appliance technician is defined as "a person, firm, corporation, or company that either in person or through a representative, is engaged in and responsible for the installation, testing, servicing, or replacement of heating, ventilation, air conditioning (HVAC) equipment, combustion appliances and equipment, and/or gas fireplaces or other decorative combustion equipment."

IF YOUR CO ALARM SOUNDS**WARNING!**

If your CO Alarm indicates the presence of carbon monoxide (CO) which can kill you. When your CO Alarm sounds, you must not ignore it!

IF THE ALARM SIGNAL SOUNDS:

- Operate the Test/Silence button.
- Call your emergency services, fire department or 911. Write down the number of your local emergency service here:
- Immediately move to fresh air—outdoors or by an open door or window. Do a head count to check that all persons are accounted for. Do not re-enter the premises, or move away from the open door or window until the emergency services responder has arrived, the premises have been aired out, and your CO Alarm remains in its normal condition.
- After following steps 1-3, if your CO Alarm reactivates within a 24-hour period, repeat steps 1-3 and call a qualified appliance technician to investigate for sources of CO from fuel-burning equipment and appliances, and inspect for proper operation of this equipment. If problems are identified during this inspection have the equipment serviced immediately. Note any combustion equipment not inspected by the technician, and consult the manufacturers' instructions, or contact the manufacturers directly, for more information about CO safety and this equipment. Make sure that motor vehicles are not, and have not, been operating in an attached garage or adjacent to the residence. Write down the number of a qualified appliance technician here:

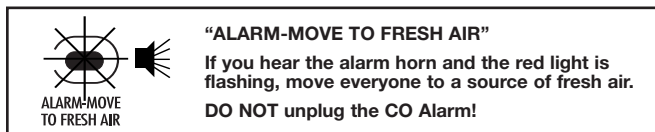

WARNING!
Alarms have various limitations. See "General Limitations of CO Alarms" for details.

Continued...

USING THE SILENCE FEATURES

The Silence Feature is intended to temporarily silence your CO Alarm's horn while you correct the problem—it will not correct a CO problem. While the Alarm is silenced, it will continue to monitor the air for CO.

To Activate the Silence Feature: press and hold the Test/Silence button until the horn is silent.

Once you activate the Silence Feature: the Silence cycle will last approximately 4 minutes.

- If CO levels drop below alarm levels after 4 minutes, the unit will return to normal operation and remain silent.
- If CO levels do not drop below alarm levels, the unit will alarm again.

WARNING!

The Silence Feature is for your convenience only and will not correct a CO problem. Always check your home for a potential problem after any alarm. Failure to do so can result in injury or death.

WARNING!

NEVER disconnect your CO Alarm to silence the horn. Use the Silence Feature. Unplugging the CO Alarm and removing the batteries removes your protection!

SILENCING THE LOW BATTERY WARNING

This silence feature can temporarily quiet the low battery warning "chirp" for up to 8 hours without having to remove the battery. You can silence the low battery warning "chirp" by pressing the Test/Silence button on the alarm cover.

Once the low battery warning "chirp" silence feature is activated, the unit continues to flash the red light once a minute for 8 hours. After 8 hours, the low battery "chirp" will resume. Replace the battery as soon as possible, this unit will not operate without battery power!

To deactivate this feature: Press the Test/Silence button again. The unit will go into Test Mode and the low battery warning will resume (LED flashes and unit sounds "chirp" once a minute.)

If you cannot silence the low battery warning, replace your battery immediately.

SILENCING THE END OF LIFE SIGNAL

This silence feature can temporarily quiet the End of Life warning "chirp" for up to 2 days. You can silence the End of Life warning "chirp" by pressing the Test/Silence button. The horn will chirp, acknowledging that the End of Life silence feature has been activated.

After approximately 2 days, the End of Life "chirp" will resume. After approximately 2-3 weeks the End of Life warning cannot be silenced.

TESTING AND MAINTENANCE**WEEKLY TESTING**

You can test this CO Alarm by pressing the Test/Silence button on the Alarm cover until alarm sounds.

During testing, you will hear a loud alarm sequence – 4 beeps, pause, 4 beeps, pause.

WARNING!

- If the Alarm ever fails to test properly, replace it immediately. Products under warranty may be returned to the manufacturer for replacement. See "Limited Warranty" at the end of this manual.

- DO NOT stand close to the Alarm when the horn is sounding. Exposure at close range may be harmful to your hearing. When testing, step away when horn starts sounding.
- NEVER use vehicle exhaust! Exhaust may cause permanent damage and voids your warranty.

REGULAR MAINTENANCE

To help prevent CO problems and reduce the risk of CO poisoning:

- Test it every week as described in "Weekly Testing."
- Vacuum the CO Alarm cover at least once a month, using the soft brush attachment. Never use water, cleaners, or solvents, since they may damage the unit. Test the Alarm again after vacuuming.
- Replace the battery immediately when you hear the "Low Battery Warning".

The Low (or Missing) Battery Warning:

The horn will "chirp" once a minute.

REPLACING THE BATTERY**Choosing a Replacement Battery:**

This unit requires one standard 9V alkaline battery. The following alkaline batteries are acceptable as replacements: Duracell #MN1604 or MX1604; Eveready "Energiizer" 522. You can also use an Ultralife 9 volt lithium battery #UBVL, for longer service life between battery changes. These replacement batteries are commonly available at local retail stores.

IMPORTANT!

Use only the alkaline or lithium replacement batteries listed. The unit may not operate properly with other batteries. Never use rechargeable batteries since they may not provide a constant charge.

CAUTION!

DO NOT spray cleaning chemicals or insect sprays directly on or near the CO Alarm. DO NOT point over the CO Alarm. Doing so may cause permanent damage.

IMPORTANT!

Household cleaners, aerosol chemicals and other contaminants can affect the sensor. When using any of these materials near the CO Alarm, make sure the room is well ventilated.

IMPORTANT!

If your home is being fumigated, unplug the unit temporarily and put it where it will not be exposed to chemicals or fumes. When fumigation is complete and all traces of fumes clear, plug the unit back in and reset it.

WHAT YOU NEED TO KNOW ABOUT CO WHAT IS CO?

CO is an invisible, odorless, tasteless gas produced when fossil fuels do not burn completely, or are exposed to heat (usually fire). Electrical appliances typically do not produce CO.

These fuels include: Wood, coal, charcoal, oil, natural gas, gasoline, kerosene, and propane.

Common appliances are often sources of CO. If they are not properly maintained, are improperly ventilated, or malfunction, CO levels can rise quickly. CO is a real danger now that homes are more energy efficient. "Air-tight" homes with added insulation, sealed windows, and other weatherproofing can "trap" CO inside.

SYMPTOMS OF CO POISONING

These symptoms are related to CO POISONING and should be discussed with ALL household members.

Mild Exposure: Slight headache, nausea, vomiting, fatigue ("flu-like" symptoms).

Medium Exposure: Throbbing headache, drowsiness, confusion, fast heart rate.

Extreme Exposure: Convulsions, unconsciousness, heart and lung failure. Exposure to carbon monoxide can cause brain damage, death.

IMPORTANT!

This CO Alarm measures exposure to CO over time. It alarms if CO levels are extremely high in a short period of time, or if CO levels reach a certain minimum over a long period of time. The CO Alarm generally sounds an alarm before the onset of symptoms in average, healthy adults. Why is this important? Because you need to be warned of a potential CO problem while you can still react in time. In many reported cases of CO exposure, victims may be aware that they are not feeling well, but become disoriented and can no longer react well enough to exit the building or get help. Also, young children and pets may be the first affected. The average healthy adult might not feel any symptoms when the CO Alarm sounds. However, people with cardiac or respiratory problems, infants, unborn babies, pregnant mothers, or elderly people can be more quickly and severely affected by CO. If you experience even mild symptoms of CO poisoning, consult your doctor immediately!

FINDING THE SOURCE OF CO AFTER AN ALARM

Carbon monoxide is an odorless, invisible gas, which often makes it difficult to locate the source of CO after an alarm. These are a few of the factors that can make it difficult to locate sources of CO:

- House well ventilated before the investigator arrives.
- Problem caused by "backdrafting."
- Transient CO problem caused by special circumstances.

Because CO may dissipate by the time an investigator arrives, it may be difficult to locate the source of CO. **BRK Brands, Inc. shall not be obligated to pay for any carbon monoxide investigation or service call.**

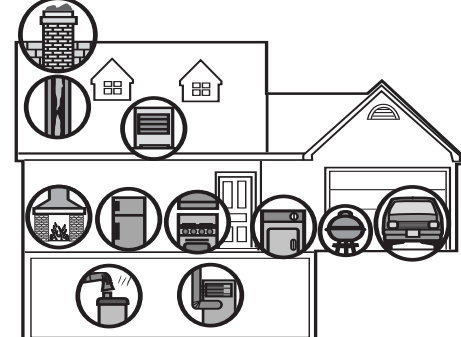
POTENTIAL SOURCES OF CO IN THE HOME

Fuel-burning appliances like: portable heater, gas or wood burning fireplace, gas kitchen range or cooktop, gas clothes dryer.

Damaged or insufficient venting: corroded or disconnected water heater vent pipe, leaking chimney pipe or flue, or cracked heat exchanger, blocked or clogged chimney opening

Improper use of appliance/device: operating a barbecue grill or vehicle in an enclosed area (like a garage or screened porch).

Transient CO Problems: "transient" or on-again-off-again CO problems can be caused by outdoor conditions and other special circumstances.

The following conditions can result in transient CO situations:

- Excessive spillage or reverse venting of fuel appliances caused by outdoor conditions such as:
 - Wind direction and/or velocity, including high, gusty winds. Heavy air in the vent pipes (cold/humid air with extended periods between cycles).
 - Negative pressure differential resulting from the use of exhaust fans.
 - Several appliances running at the same time competing for limited "fresh air."
 - Vent pipe connections vibrating loose from clothes dryers, furnaces, or water heaters.
- Obstructions in or unconventional vent pipe designs which can amplify the above situations.
- Extended operation of unvented fuel burning devices (range, oven, fireplace).
- Temperature inversions, which can trap exhaust close to the ground.
- Car idling in an open or closed attached garage, or near a home.

These conditions are dangerous because they can trap exhaust in your home. Since these conditions can come and go, they are also hard to recreate during a CO investigation.

HOW CAN I PROTECT MY FAMILY?

A CO Alarm is an excellent means of protection. It monitors the air and sounds a loud alarm before Carbon Monoxide levels become threatening for average, healthy adults.

A CO Alarm is not a substitute for proper maintenance of home appliances.

To help prevent CO problems and reduce the risk of CO poisoning:

- Test and clean chimneys and flues yearly. Keep them free of debris, leaves, and nests for proper air flow. Also, have a professional check for rust and corrosion, cracks, or separations. These conditions can prevent proper air movement and cause backdrafting. Never "cap" or cover a chimney in any way that would block air flow.
- Test and maintain all fuel-burning equipment annually. Many local gas or oil companies and HVAC companies offer appliance inspections for a nominal fee.
- Make regular visual inspections of all fuel-burning appliances. Check appliances for excessive rust and scaling. Also check the flame on the burner and pilot lights. The flame should be blue. A yellow flame means fuel is not being burned completely and CO may be present. Keep the blower door on the furnace closed. Use vents or fans when they are available on all fuel-burning appliances. Make sure appliances are vented to the outside. Do not grill or barbecue indoors, or in garages or on screened porches.
- Check for exhaust backflow from CO sources. Check the draft hood on an operating furnace for a backdraft. Look for cracks on furnace heat exchangers.
- Check the house or garage on the other side of shared wall.
- Keep windows and doors open slightly. If you suspect that CO is escaping into your home, open a window or a door. Opening windows and doors can significantly decrease CO levels.

In addition, familiarize yourself with all enclosed materials. Read this manual in its entirety, and make sure you understand what to do if your CO Alarm sounds.